

INSTALLATION INFORMATION

3 - 2.5T DOGBONE STYLE LIFTING ANCHORS
WEIGHT: 5000 LBS / 2268 KG

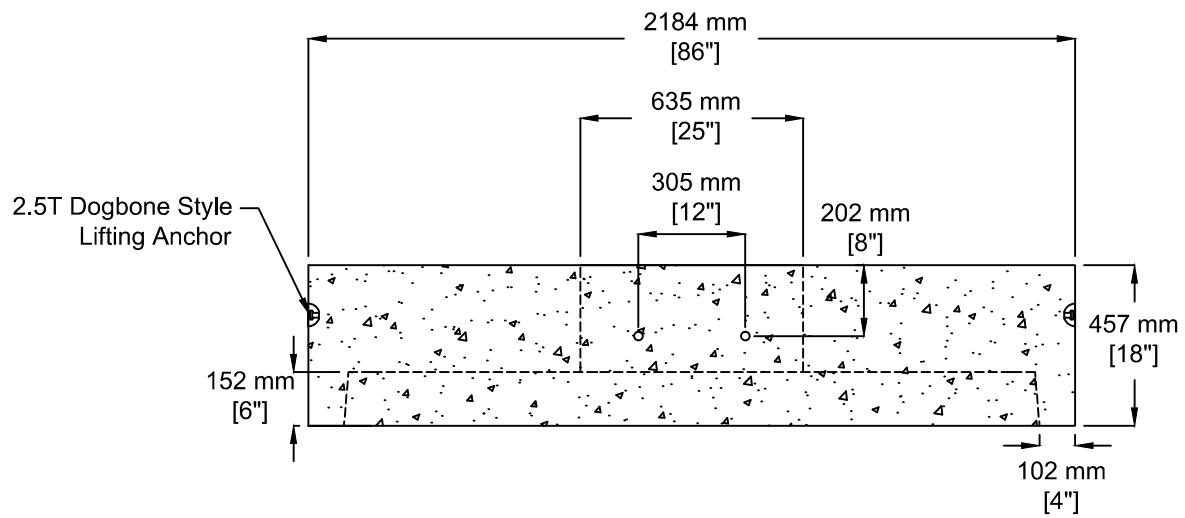

TEL: 250-495-7556
socp@socp.ca
www.socp.ca

1800 ID (72") Manhole Lid
- 635 mm Op

Product #

0376